



SPECIFICATIONS

SS-680NP-ML* CC DRIVER

Model: SS-680NP-ML*

Power: 680W

Rev.: V02

Release date: 2026-03-13

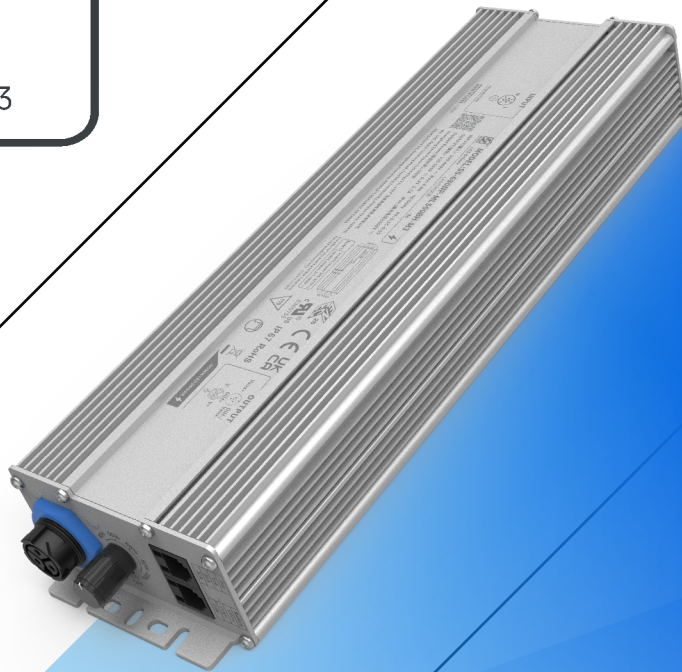

SS-680NP-ML Series LED Driver

Features

- Efficiency up to 97%
- Dimming: 0-10V,PWM,Resistor,Timing
- Surge protection: CM: 6kV, DM: 6kV
- AUX Power: 12V/0.3A
- Constant Lumen, Life Warning
- Communication with PC
- Protections: SCP/OTP/UVP/OPP
- Warranty: 5 years



RoHS



Description

SS-680NP-ML500* is 680W non-isolated constant current LED Driver with 180-528Vac input and wide O/P voltage range and adjustable O/P current by program. LED luminaire manufactures can easily design luminaires and reduce cost.

Applications:

Horticulture lighting, Stadium lighting, Fish lighting

Model List:

Model	AC Input Range	Max. Pout	Vout Range	Full Power Vo Range	Iout	THD (Typ.)	PF (Typ.)	Eff. (Typ.)	Max.Tc
SS-680NP-ML500*	180-528Vac	680W	150-500V	252-500V	0.35-2.70A	10%	0.95	97%	90°C

Note:

1.Default Tested: at 400Vac, full load, Ta 25°C;

2. The performance of the LED Driver can be guaranteed within the full power Vo range. The voltage lower than full power Vo range, it is need to test the performance with the LED module ;

SS-680NP-ML Series LED Driver

“*” Means Additional Function

“*”	AC INPUT		DC OUTPUT			Dimming		Output-Ground	Remark
	Cable	M19-3Pin	Cable	M19-2Pin	M19-3Pin	Knob&RJ25	M12-3Pin		
BHB	✓		✓			✓			
BHB-G	✓		✓			✓		✓	
BHB-M2		✓		✓		✓			
BHB-M3		✓			✓	✓		✓	
BH-M2		✓		✓			✓		
BH-M3		✓			✓		✓	✓	

Input Characteristics:

Parameter	Min.	Typ.	Max.	Remark
Rated AC Input Range	200Vac		277Vac	<Ta:45°C
	277Vac		480Vac	<Ta:50°C
AC Input Range	180Vac		528Vac	Reference Derating Curve
Input Frequency Range	47Hz	50/60Hz	63Hz	
Max Input Current			4.0A	200Vac, Full load
Max Input Power			800W	200Vac, Full load
Max Inrush Current(220Vac)			15A	Cold start
Max Inrush Current(347Vac)			20A	Cold start
Max Inrush Current(400Vac)			23A	Cold start
Max Inrush Current(480Vac)			25A	Cold start
Power Factor	0.95	0.97		220Vac/50Hz, Full load
	0.90			200-480Vac, 70-100% load
THD		8%	10%	347Vac/60Hz, Full load
			20%	200-480Vac, 70-100% load

SS-680NP-ML Series LED Driver

O/P Characteristics:

Parameter	Min.	Typ.	Max.	Remark
O/P Voltage Range	150V		500V	Power derated @150-252V
Rated O/P Voltage	252V		500V	$P_o = V_o \cdot I_o = 680W$, Full load
Rated O/P Current	1.36A		2.70A	2.70A for 252V, 1.36A for 500V
Adj. O/P Current (AOC) Range	0.35A		2.70A	Adjustable by program
No Load Voltage			600V	
Efficiency @220Vac	92.0%	94.0%		O/P 500V/1.36A
Efficiency @347Vac	94.0%	96.0%		O/P 500V/1.36A
Efficiency @400Vac	95.0%	97.0%		O/P 500V/1.36A
Efficiency @480Vac	95.0%	97.0%		O/P 500V/1.36A
O/P Current Tolerance	-5%		+5%	
O/P Current Ripple(PK-AV)		5%	10%	Full load
Start-up Current Overshoot			10%	Full load
Start-up Time			0.5S	230Vac, Full load
Line Regulation	-2%		+2%	
Load Regulation	-2%		+2%	
Temperature Coefficient	-0.03%/°C		+0.03%/°C	$T_c: 0^\circ C \sim 90^\circ C$
OTP	90°C		100°C	Drop current when OTP, and it can be automatically restored after the abnormality is removed.
Short Circuit Protection				Driver will not be damaged, Constant current mode

SS-680NP-ML Series LED Driver

Other Characteristics:

Parameter		Min.	Typ.	Max.	Remark
AUX Power	O/P Voltage	10.8V	12V	13.8V	
	O/P Current			300mA	
0-10V Dimming (Optional)	Dim Vmax	0V		12V	Negative dimming by programming Dimming prohibits reverse connection. DIM+ source current 110uA .
	Dim Range	10%loset		100%loset	
	Rec.Dim Range	0V		10V	
10-0V Dimming (Optional)	Rec.Dim Range	0V		10V	DIM+ Maximum sink current is 40uA Dimming prohibits reverse connection. 5-0V by programming
PWM Dimming	PWM High	9.8V		10.2V	
	PWM Low	0V		0.3V	DIM+ source current 110uA .
	Frequency	1KHz		2KHz	Dimming prohibits reverse connection.
	PWM Duty	0%		100%	
Resistor Dimming	Resistance	0Kohm		100Kohm	
	Dim Range	10%loset		100%loset	DIM+ source current 110uA .
0-10V Dim to Off	Dim off	7%	8%	9%	By DC voltage, PWM, resistance dimming ratio
	Dim on	8%	9%	10%	By DC voltage, PWM, resistance dimming ratio
Timing Curve(Optional)		By programming			Set by program
Constant Lumen(Optional)		By programming			Set by program
Life Warning(Optional)		By programming			Set by program
Life Time(Tc≤75°C)		≥50,000 hours			80% Load, 400Vac
MTBF		198,800 hours			400Vac,Full load, Ta=25°C (MIL-HDBK-217F)
Tc		90°C			
Warranty		5 years			Tc:75°C
Net Weight		2200g			
Dimension		311mm*89.5mm*44.5mm			L x W x H

NOTE:

- 1.All the parameters above are tested Ta 25°C and LED load, unless specified.
- 2.When using resistor dimming (parallel connection of dimming wires), if the number of parallels is: N, the dimming resistor should be realized 0-100% dimming range, resistance value: 91KΩ/N.

SS-680NP-ML Series LED Driver

Environmental Requirements

Parameter	Min.	Typ.	Max.	Remark
Operating Temperature(Tcase)	-40°C	25°C	+90°C	
Storage Temperature	-40°C	25°C	+90°C	
Operation Humidity	10%RH		90%RH	
Storage Humidity	5%RH		95%RH	
Altitude	-65m		4000m	

Safety and EMI/EMS Standards

Certification	Standard	Status	Remark
UL	UL8750	✓	
CUL	CAN/CSA C22.2 No.250.13	✓	
ENEC	EN 61347-1 EN 61347-2-13 EN IEC 62384	✓	
RCM	AS/NZS61347.2.13		
CCC	GB/T 19510.1 GB/T 19510.213		
CE	EN 61347-1 EN 61347-2-13 EN 62493	✓	
	EN 301 489-1 EN 301 489-3 EN 300 330 EN 62479/EN 50663/EN 50665/EN 50364		For NFC wireless products

SS-680NP-ML Series LED Driver

Safety and EMI/EMS Standards

EMI/EMS	Standard	Status	Remark
Conduction Emission	EN IEC 55015	✓	
	GB/T 17743		
	FCC Part 15 Subpart B;ANSI C63.4	✓	ClassB
Radiation Emission	EN IEC 55015	✓	
	GB/T 17743		
	FCC Part 15 Subpart B;ANSI C63.4	✓	ClassB
Harmonic Current Emissions	EN IEC 61000-3-2	✓	ClassC
	GB 17625.1		ClassC
Surge	IEC/EN61000-4-5	✓	DM: 6kV,CM: 6kV,Criterion B
	ANSI/C82.77-5	✓	DM: 6kV,CM: 6kV,Criterion B
Ring Wave	IEC/EN 61000-4-12	✓	DM: 6kV,CM: 6kV,Criterion B
	ANSI/C82.77-5	✓	DM: 6kV,CM: 6kV,Criterion B

SS-680NP-ML Series LED Driver

Safety Test Items:

Safety Test Items	Technical Indicators		Remark
Insulation Requirements	UL Insulation Requirements	ENEC Insulation Requirements	
Input-Case	2U+1000	2U+1000	Basic insulation
Input-Dim	2U+1000	4U+2000	Reinforced insulation
Dim-Case	500Vac	500Vac	Basic insulation
Insulation Resistance	$\geq 10M\Omega$		Input-DIM, Test voltage: 500Vdc
Ground Resistance	$\leq 0.1\Omega$		25A/1min
Leakage Current	$\leq 0.75mA$		480Vac

NOTE:

1. SOSEN warrants the LED Driver itself complies with EMC standard. However, LED Driver's EMC should be re-checked when integrated into lighting systems due to unexpected interference as component.
2. Please short (ACL and ACN), (V+ and V-), (Dim+ and Dim - and Vaux+) when Hi-pot test (Turn off ARC) .
3. When applying withstand voltage to ground, the input and output lines need to be short-circuited together.

Performance Curves:

Input Inrush Current

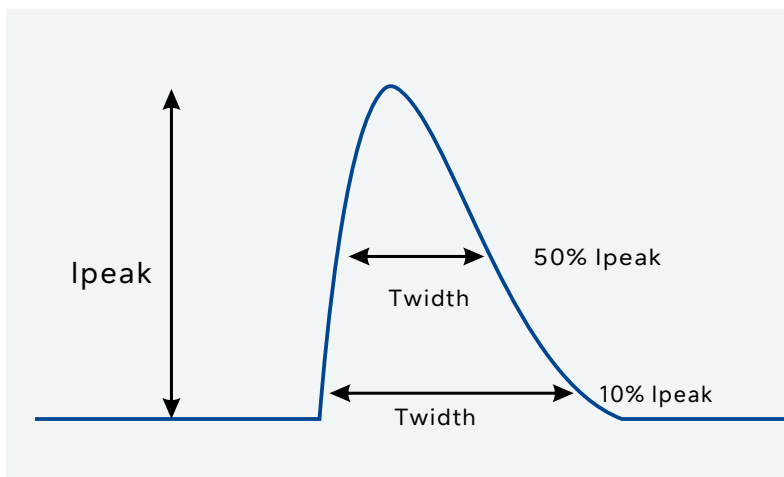

Vin	Ipeak	T(@10% of Ipeak)	T(@50% of Ipeak)
220Vac	15A	10mS	3mS
347Vac	20A	11mS	4mS
400Vac	23A	12mS	4mS
480Vac	25A	12mS	4mS

SS-680NP-ML Series LED Driver

Performance Curves:

O/P Voltage Vs. O/P Current(Dim/AOC Window)

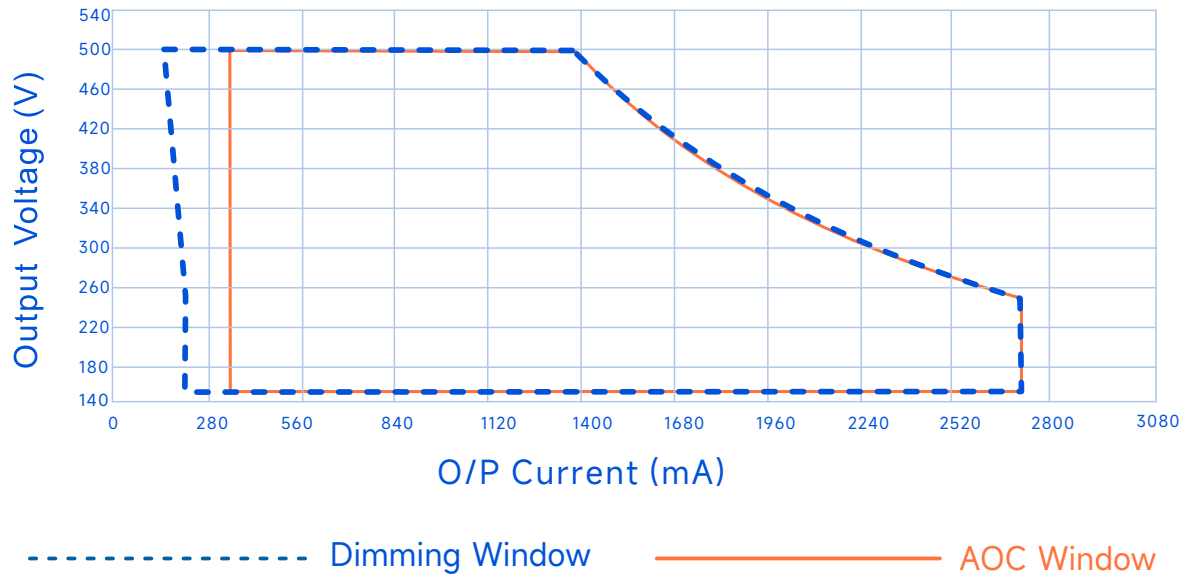

SS-680NP-ML Series LED Driver

Performance Curves:

Efficiency Vs. O/P Voltage ($V_{in}=220V_{ac}$)

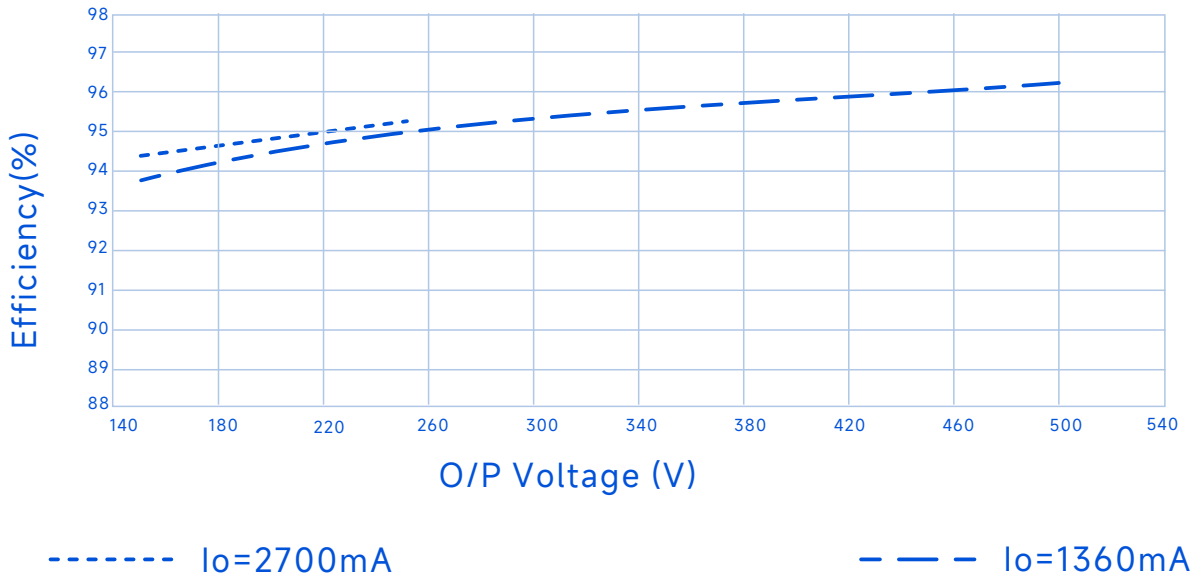

Efficiency Vs. O/P Voltage ($V_{in}=347V_{ac}$)

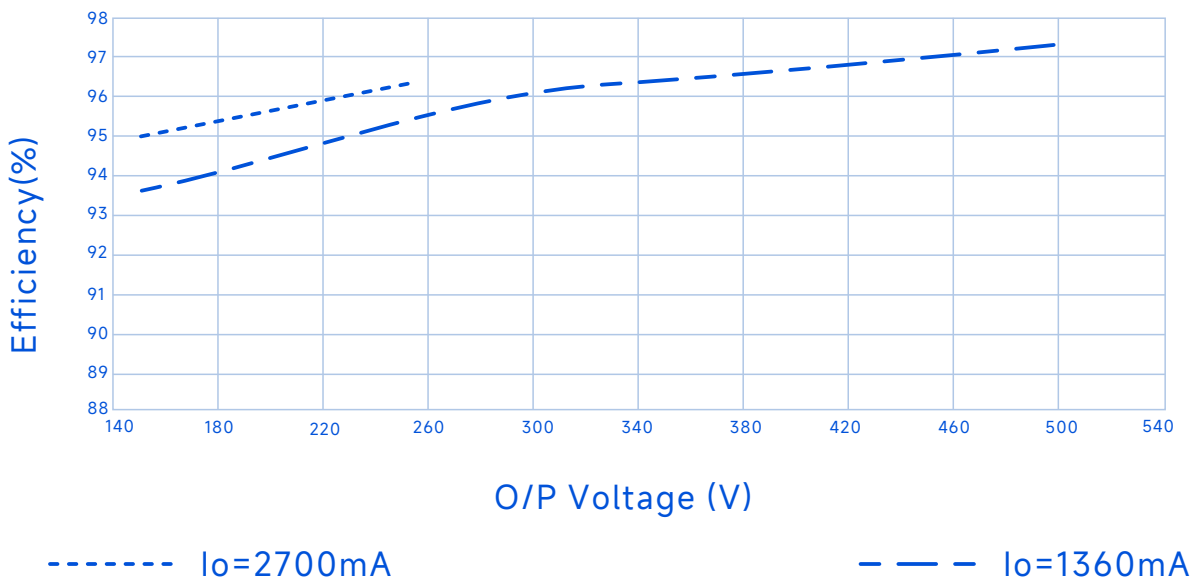

SS-680NP-ML Series LED Driver

Performance Curves:

Efficiency Vs. O/P Voltage ($V_{in}=400V_{ac}$)

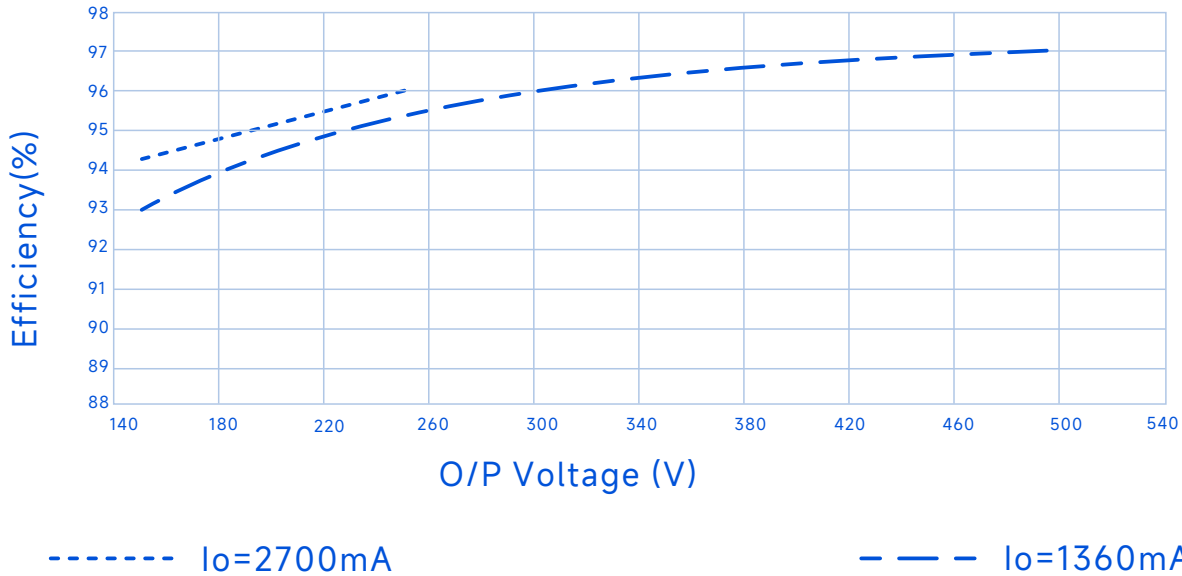

Efficiency Vs. O/P Voltage ($V_{in}=480V_{ac}$)

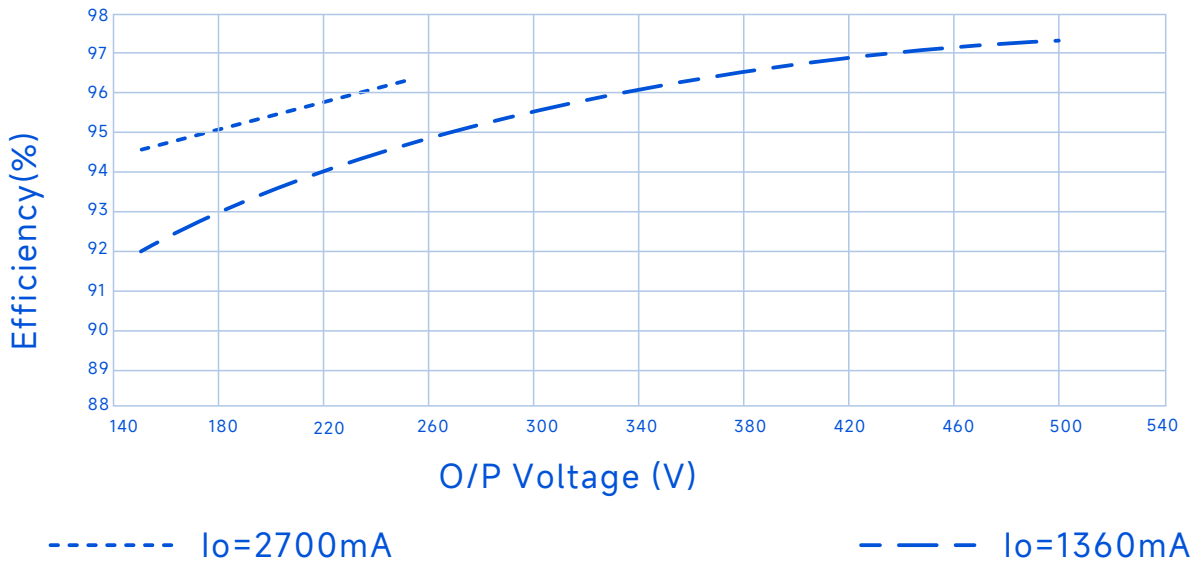

SS-680NP-ML Series LED Driver

Performance Curves:

Power Factor Vs. O/P Power

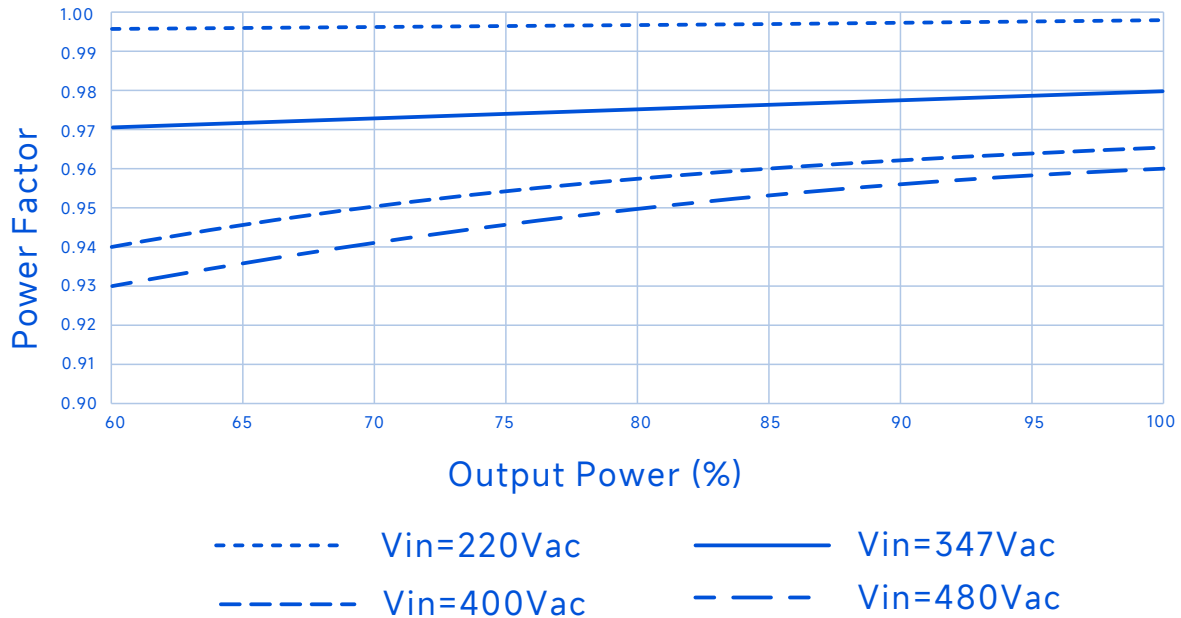

THD Vs. O/P Power

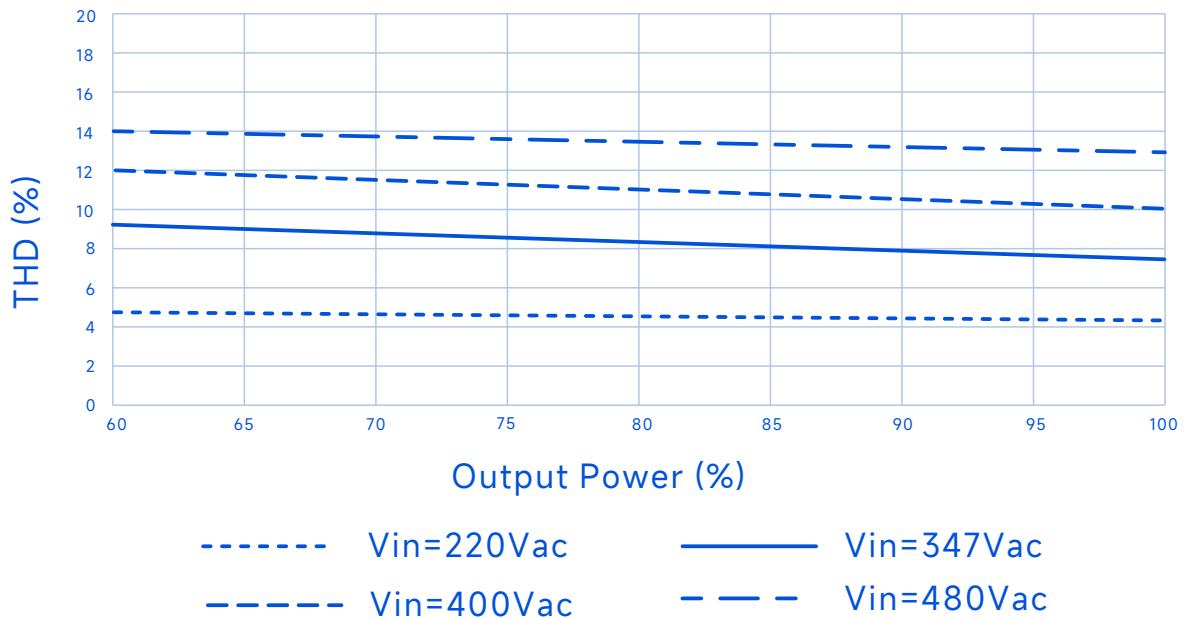

SS-680NP-ML Series LED Driver

Performance Curves:

O/P Power Vs. Input Voltage

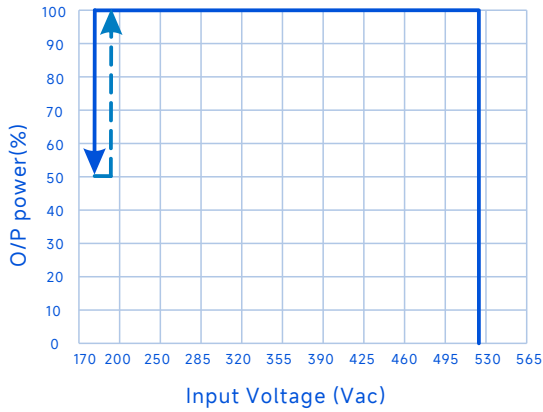

O/P Power Vs. Case Temperature

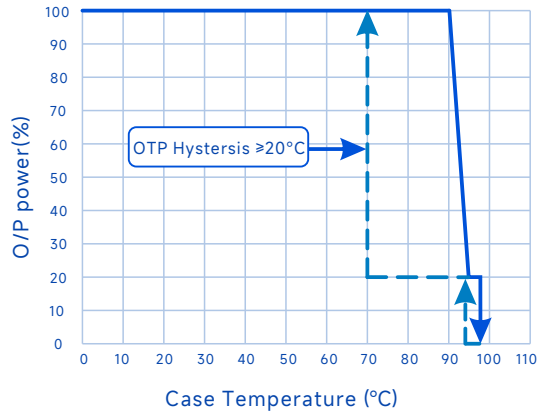

O/P Power Vs. Dimming

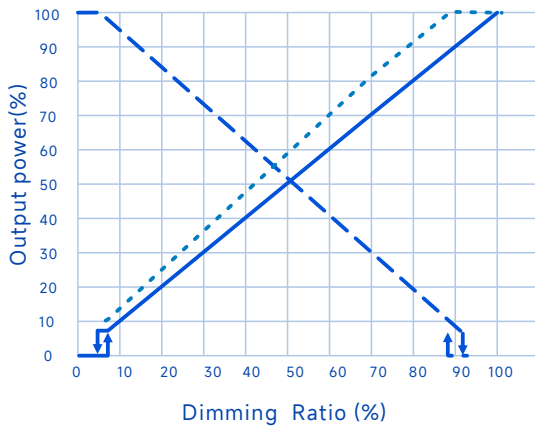

- 0-10V, PWM
- - - 10-0V
- Resistor Dimming

Lifetime Vs. Case Temperature

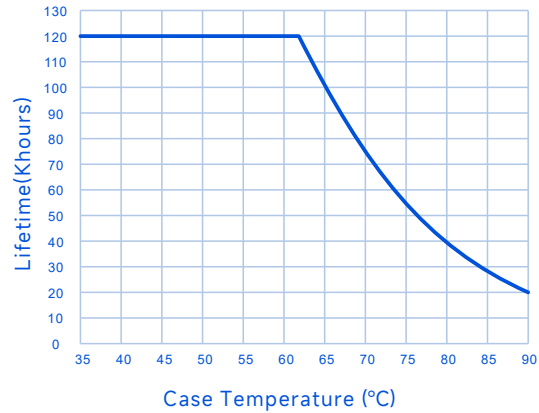

Constant Lumen Output

Constant Lumen Output are design to maintain fixture's stable output lumen by increasing driver's output current within driver's life span to counteract LED lumen degradation.

Programming connection diagram

Legacy Timer: Driver's O/P follows the pre-programmed timing curve after turn-on.

Auto-Adjust by Percentage: Driver's O/P will be adjusted by automatically changed dimming curve by the period percentage based on the latest 5 dimming curve.

Auto-Adjust by Mid-point: Driver's O/P will be adjusted by automatically changed dimming curve by mid-point based on the latest 5 dimming curve.



Note:

1. During programming, the driver does not need to be powered on to achieve all programming functions.
2. For a driver that is powered on and in use, all programming functions can be performed without needing to disconnect the power.
3. It can operate independently of a PC to achieve offline programming.

SS-680NP-ML Series LED Driver

Dimming parameter settings

	Parameter	Remark
Dimming Settings	Dimming voltage default 10V (source current)	Factory Default Mode(other models)
	Dimming voltage default 0V (sink current)	Factory Default Mode(BHB* models)

Note:

According to the application of the dimmer, customers can set the two modes of “dimming voltage default 10V (output current)” / “dimming voltage default 0V (draw current)” by Songsheng programming software.

Settings Interface

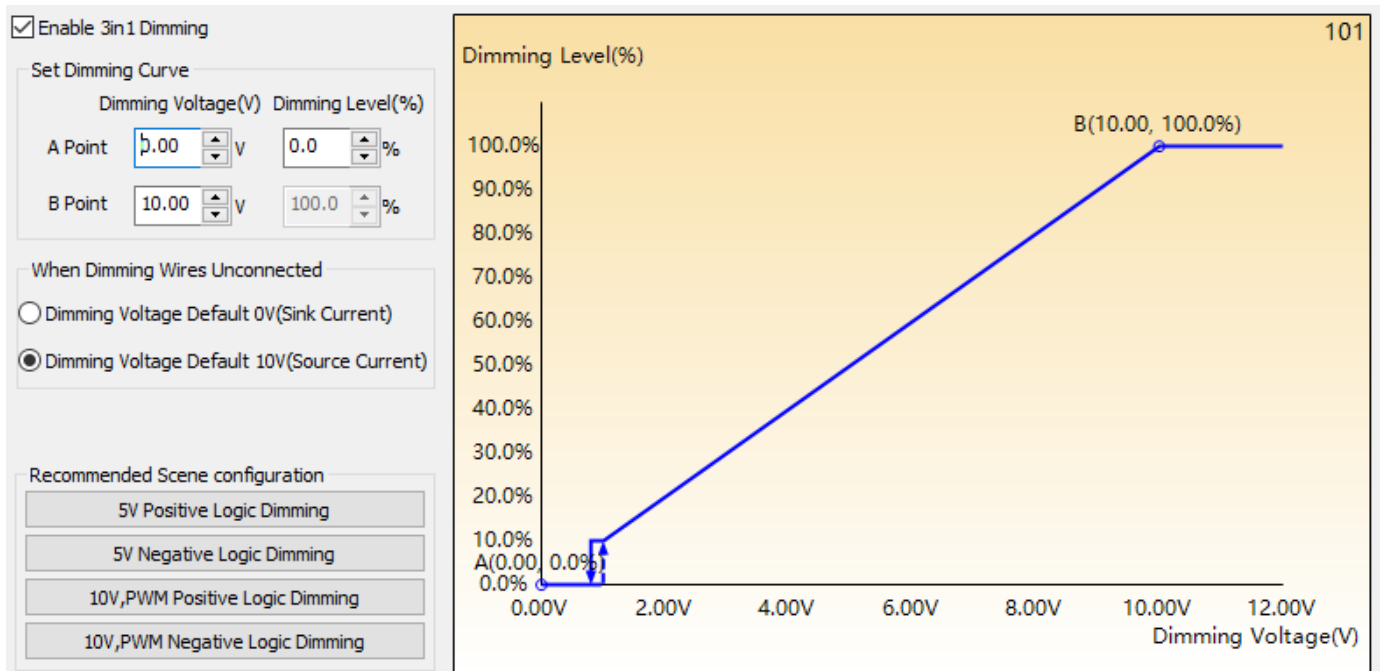

SS-680NP-ML Series LED Driver

Mechanical Characteristics(BHB/BHB-G model)

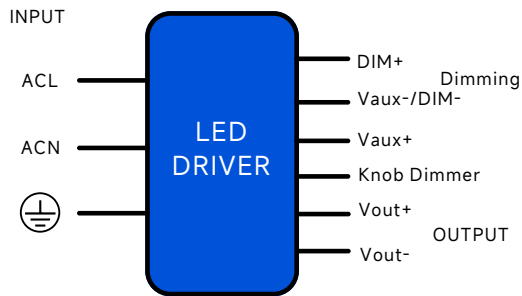

AC Input Cable(Exposed Length 450±10mm):

Global model: SOOW,3*17AWG,O.D: 9.8mm,Brown:L,Blue:N,Yellow/Green:⊕

DC O/P Cable(Exposed Length 250±10mm):

Global model: SOOW,2*17AWG,O.D: 9.3mm,Brown:V+ Blue:V-
Global model:SOOW,3*17AWG,O.D:9.8mm,Brown:V+,Blue:V-,
Yellow/Green:GND(Suffix-G) ⊕

DIM/AUX Power/Programming Cable:

Knob Dimmer, RJ25 port

Name Description	Standard Code	mm(in.)
Overall Length	L1	311(12.24)
Mounting Hole Length	L2	298(11.73)
Case Length	L3	284(11.18)
Case Width	W1	89.5(3.52)
Mounting Hole Width	W2	40(1.57)
Case Height	H	44.5(1.75)
TC Point Position	X	85(3.35)
TC Point Position	Y	33(1.30)

Note

1,Please follow the "LED Driver User Manual" obtained from SOSEN's official website for assembly.

2,AC Input Cable,DC O/P Cable,DIM/AUX Power/Programming Cable:
Peeled length of cable:43±5mm, Tinned length of wire:10±2mm

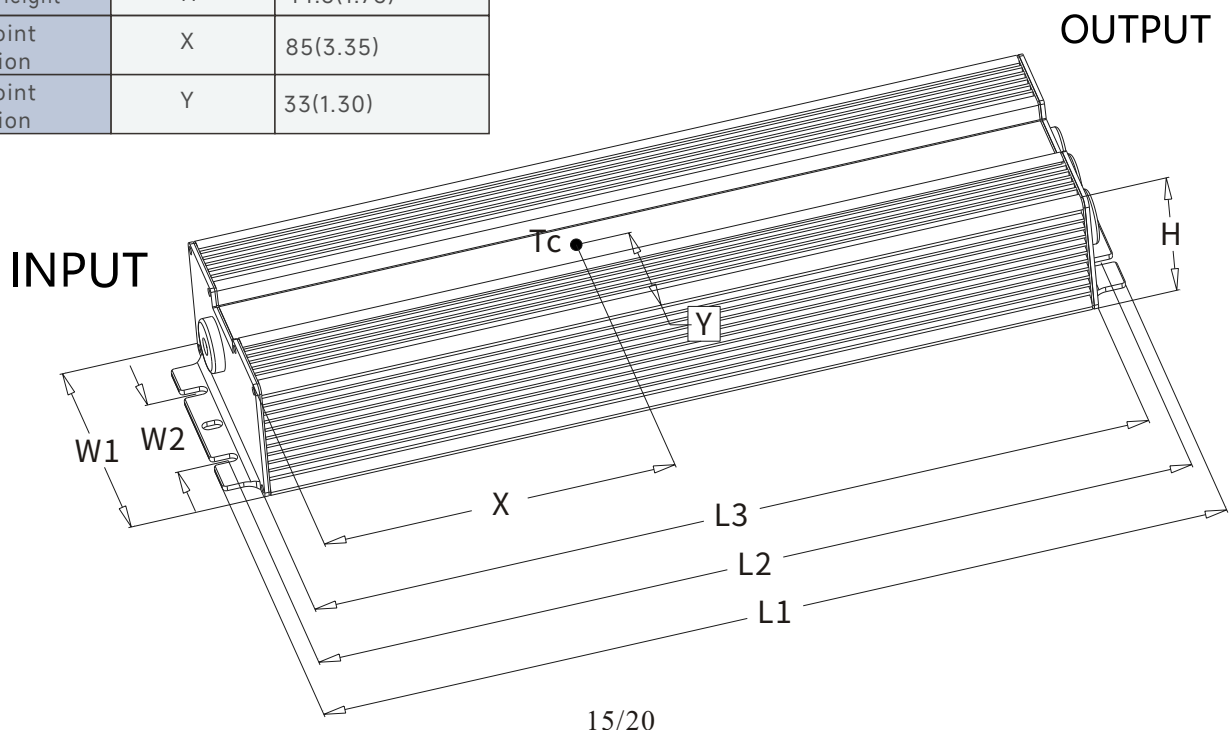

SS-680NP-ML Series LED Driver

Mechanical Characteristics(BH-M2/BH-M3 model)

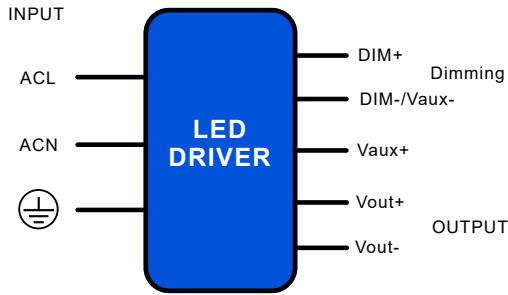

AC INPUT	DC OUTPUT		DIM OUTPUT
M19LLT-3 Pin	M19LLT-2 Pin	M19LLT-3 Pin	M12LLT-3 Pin
M19JNICON-3 Pin	M19JNICON-2 Pin	M19JNICON-3 Pin	M12JNICON-3 Pin

Name Description	Standard Code	mm(in.)
Overall Length	L1	311(12.24)
Mounting Hole Length	L2	298(11.73)
Case Length	L3	284(11.18)
Case Width	W1	89.5(3.52)
Mounting Hole Width	W2	40(1.57)
Mounting Hole Width	W3	21(0.83)
Case Height	H	44.5(1.75)
TC Point Position	X	85(3.35)
TC Point Position	Y	33(1.30)

Note

- 1, Please follow the "LED Driver User Manual" obtained from SOSEN's official website for assembly.
- 2, AC Input Cable, DC O/P Cable, DIM/AUX Power/Programming Cable:
Peeled length of cable: 43±5mm, Tinned length of wire: 10±2mm

INPUT

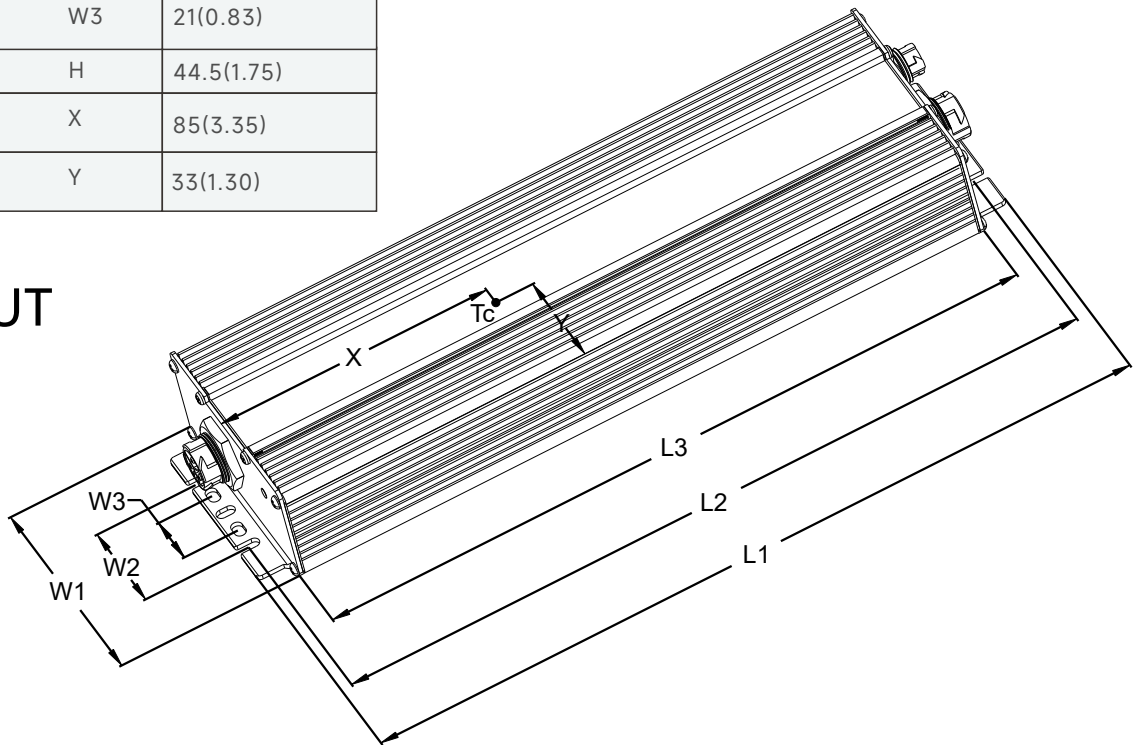

OUTPUT

SS-680NP-ML Series LED Driver

Mechanical Characteristics(BHB-M2/BHB-M3 model)

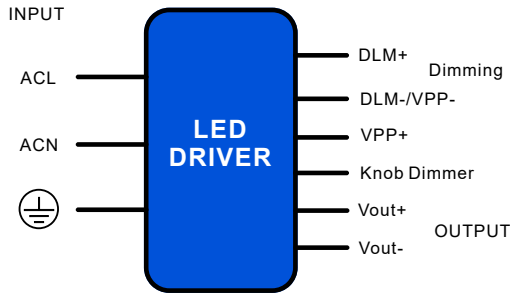

AC INPUT	DC OUTPUT	
M19LLT-3 Pin	M19LLT-2 Pin	M19LLT-3 Pin
M19JNICON-3 Pin	M19JNICON-2 Pin	M19JNICON-3 Pin
DIM/Programming Cable Knob Dimmer, RJ25 port		

Name Description	Standard Code	mm(in.)
Overall Length	L1	311(12.24)
Mounting Hole Length	L2	298(11.73)
Case Length	L3	284(11.18)
Case Width	W1	89.5(3.52)
Mounting Hole Width	W2	40(1.57)
Mounting Hole Width	W3	21(0.83)
Case Height	H	44.5(1.75)
TC Point Position	X	85(3.35)
TC Point Position	Y	33(1.30)

Note

- Please follow the "LED Driver User Manual" obtained from SOSEN's official website for assembly.
- AC Input Cable, DC O/P Cable, DIM/AUX Power/Programming Cable: Peeled length of cable:43±5mm, Tinned length of wire:10±2mm

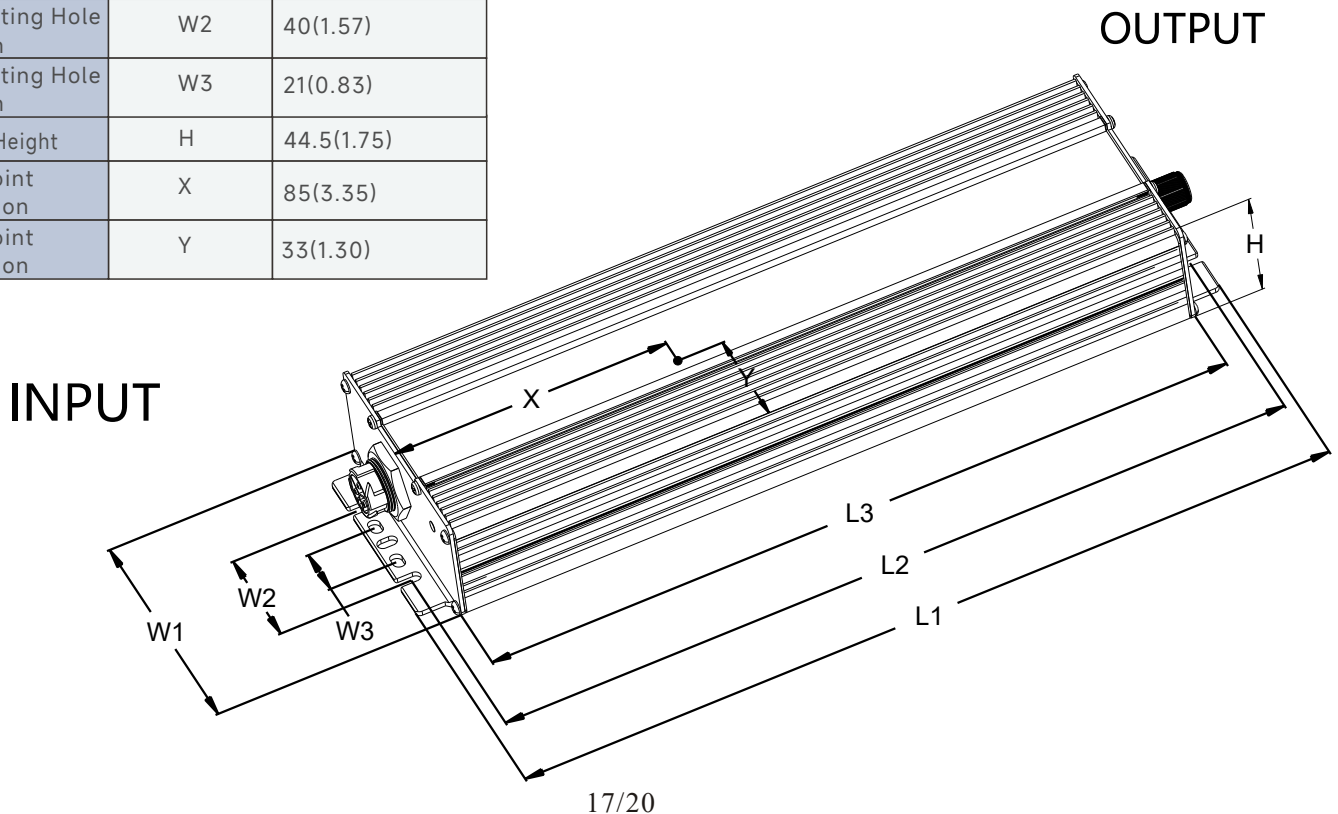

SS-680NP-ML Series LED Driver

Knob/RJ25 terminal definition:



PLUG

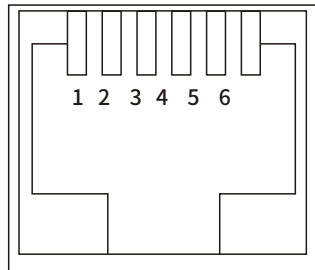

JACK

RJ25 PIN	Definition
1&6	VPP+
2&5	DIM+
3&4	DIM-/VPP-

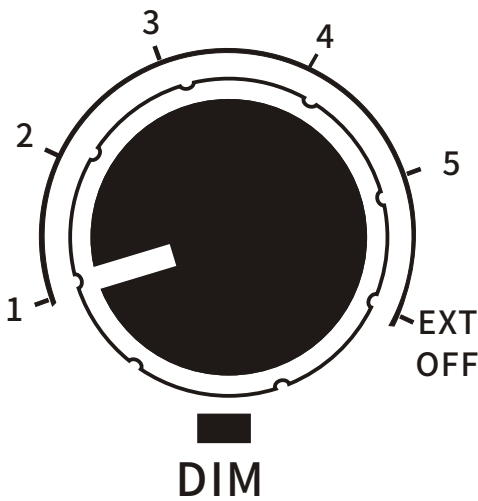

Switch	Definition
1	40%loset
2	50%loset
3	60%loset
4	80%loset
5	100%loset
EXT/OFF	External Dimming /Dim to off

SS-680NP-ML Series LED Driver



Assembly Tips

1. Dimming or AUX Power tinned connectors should be capped if not used to avoid dimming or AUX Power parts damage from external signals.
2. The trace routing on aluminum substrates is designed in compliance with creepage distance requirements specified by relevant certification regulations.
3. The creepage distance between LED+ and LED- on the aluminum substrate is designed in compliance with the relevant certification regulations.
4. Minimize the copper area on the aluminum PCB to reduce parasitic capacitance and leakage current.
5. It is recommended to design LED beads in parallel first and then in series.
6. The insulation level of LED light panels should meet the reliability design requirements.
7. It's recommended to add resistors or capacitors in parallel with the LED on PCB to reduce the risk of surge when a non isolated LED driver is used for the luminaire.
8. For other precautions, please refer to the "LED Driver User Manual".

Warning

Insufficient or compromised insulation voltage resistance in LED light panels may cause breakdown and short circuits to earth, resulting in damage to the luminaire and LED driver, and posing significant safety hazards. It is recommended to install a residual current device (RCD) during application.

Package

- Outside carton dimension: L×W×H =495mm×385mm×162mm;
- 5PCS/Carton;
- Net weight/Piece: 2.2kg;Gross weight/Carton: 12.075kg;
- Please refer to the product name, model number, manufacturer identification, QC PASS, manufacturing date on the package.

Transportation

Packaging is designed suitable for transportation by trucks, vessels and flights. The products should be avoided direct sunlight and rain, loaded/unloaded with caution.

Storage

The product storage meets the standard of the GB 3873-83.
Products should be rechecked if stored for over 1 year before assembly.

RoHS

Products comply with RoHS Directive (2011/65/EU) and amendment 2015/863/EU.

Revision History

Version	Description of Update	Updated Date	Remark
V00	Original Release	2025/07/11	
V01	Modify the programming connection diagram	2025/12/10	
V02	Add warning statements	2026/03/13	